

442



7506024159944

SOPORTE PARA CARDAN

MARCA	MODELO		
FORD	RANGER	L4 2.3	01-12

OEM MBF8T4800B

*Parque Vehicular: 321,229



8335



7506024152471

SOPORTE PARA TRANSMISIÓN

MARCA	MODELO		
FIAT	PUNTO	L4 1.4 TURBO	05-13
ALFA ROMEO	MITO	L4 1.4 TURBO	08-18

OEM 55700655

*Parque Vehicular: 3,079



8464-H



7506024155212

**SOPORTE PARA MOTOR DERECHO
 (TRANSMISIÓN AUTOMÁTICA)**

MARCA	MODELO		
MAZDA	3	L4 2.0	11-13
MAZDA	3	L4 2.3	12-13
MAZDA	3	L4 2.5	12-13

OEM BBM2-39-060A

*Parque Vehicular: 310,638

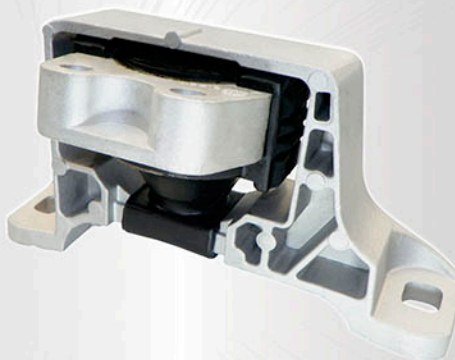

8473



7506024155304

SOPORTE PARA MOTOR FRONTAL

MARCA	MODELO		
SATURN	VUE	L4 2.2	02-06

OEM 22716726
 *Parque Vehicular: -



7506024160735

SOPORTE PARA TRANSMISIÓN

MARCA	MODELO		
DODGE	SPRINTER 2500	V6 3.0	07-09
FREIGHTLINER	SPRINTER 2500	V6 3.0	07-09
MERCEDES BENZ	SPRINTER 1500	L4 2.0	19-21
MERCEDES BENZ	SPRINTER 2500	L4 2.0	19-21
MERCEDES BENZ	SPRINTER 2500	L4 2.1	14-20
MERCEDES BENZ	SPRINTER 2500	V6 3.0	10-21
MERCEDES BENZ	SPRINTER 3500	L4 2.1	14-17
MERCEDES BENZ	SPRINTER 3500	L4 2.0	14-17
MERCEDES BENZ	SPRINTER 3500	V6 3.0	10-20
VOLKSWAGEN	CRAFTER	L4 2.0	06-16

OEM 639-242-00-13
 2E0-199-379
 *Parque Vehicular: 15,017

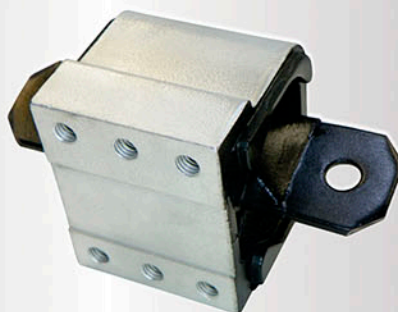



7506024159388

SOPORTE PARA TRANSMISIÓN AUTOMÁTICA

MARCA	MODELO		
MITSUBISHI	ECLIPSE	L4 2.4	06-12
MITSUBISHI	GALANT	L4 2.4	04-12

OEM MR234838

*Parque Vehicular: 75,664



8588



7506024159395

SOPORTE PARA MOTOR DERECHO

MARCA	MODELO		
HYUNDAI	ACCENT	L4 1.6	18-20
KIA	RIO	L4 1.6	18-21

OEM 21810-F9000

*Parque Vehicular: 163,607



8589-H



7506024159463

SOPORTE PARA TRANSMISIÓN AUTOMÁTICA

MARCA	MODELO		
HONDA	CIVIC	L4 2.0	16-21

OEM 50850-TBA-A81

*Parque Vehicular: 299,823

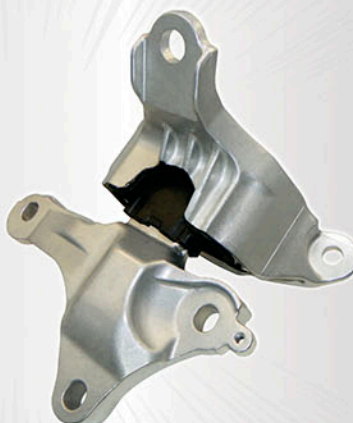

8596





7506024159500

COMPLEMENTO PARA SOPORTE DE MOTOR TRASERO STD.

MARCA	MODELO		
BUICK	CAVALIER	L4 1.5	18-21

OEM 26201840
 *Parque Vehicular: 248,593

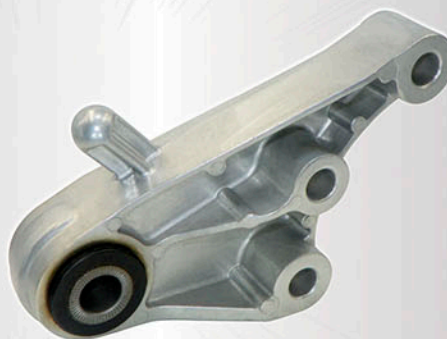

8600



7506024159548

SOPORTE PARA MOTOR DERECHO

MARCA	MODELO		
BUICK	ENVISION	L4 2.0	16-20
BUICK	ENVISION	L4 2.5	17-20

OEM 23214260, 84160405, 23379477
 *Parque Vehicular: 1,984

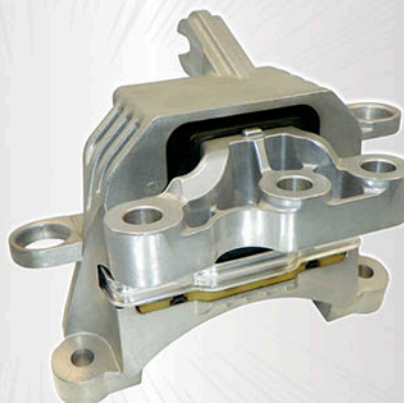

8604-H



7506024159616

BASE PARA AMORTIGUADOR FRONTAL IZQUIERDA Y DERECHA

MARCA	MODELO		
HYUNDAI	AZERA	V6 3.3	12-15
HYUNDAI	IX-35	L4 2.0	14-17
HYUNDAI	SONATA	L4 2.4	11-14
HYUNDAI	TUCSON	L4 2.0	11-13

OEM 546102Z500
 *Parque Vehicular: 54,221



8611-KIT



7506024159623

**BASE PARA AMORTIGUADOR
 TRASERA DERECHA**

MARCA	MODELO		
TOYOTA	HIGHLANDER	L4 2.7	09-11
TOYOTA	HIGHLANDER	V6 3.3	08-10
TOYOTA	HIGHLANDER	V6 3.5	08-11
TOYOTA	VENZA	L4 2.7	09-16
TOYOTA	VENZA	V6 3.5	06-19



8612-KIT



OEM 4875048070
 *Parque Vehicular: 33,587



7506024159630

**BASE PARA AMORTIGUADOR
 TRASERA IZQUIERDA**

MARCA	MODELO		
TOYOTA	HIGHLANDER	L4 2.7	09-11
TOYOTA	HIGHLANDER	V6 3.3	08-10
TOYOTA	HIGHLANDER	V6 3.5	08-11
TOYOTA	VENZA	L4 2.7	09-16
TOYOTA	VENZA	V6 3.5	06-19



8613-KIT



OEM 4876048050
 *Parque Vehicular: 33,587



7506024159654

SOPORTE PARA MOTOR TRASERO STD.

MARCA	MODELO		
ACURA	TSX	L4 2.4	08-12
HONDA	ACCORD	V6 3.5	08-12
HONDA	ACCORD	L4 2.4	08-12

OEM 50810-TA2-H01, 50810-TA0-A12
 50810-TE1-A51

*Parque Vehicular: 250,1303



8615





7506024159692

SOPORTE PARA TRANSMISIÓN AUTOMÁTICA

MARCA	MODELO		
DODGE	ATTITUDE	L3 1.2	14-15
MITSUBISHI	MIRAGE	L3 1.2	14-20

OEM 2910A106, 2910A318
 *Parque Vehicular: 185,401



8619



7506024159715

**BASE PARA AMORTIGUADOR
 TRASERA IZQUIERDA**

MARCA	MODELO		
TOYOTA	COROLLA	L4 1.8	03-19

OEM 48403-32020, 48403-02040
 48750-02050, 48755-02050, 90948-03021
 *Parque Vehicular: 312,555



8621-KIT



7506024159739

**BASE PARA AMORTIGUADOR
 FRONTAL IZQUIERDA Y DERECHA**

MARCA	MODELO		
DODGE	NEON	L4 1.4	16-21
DODGE	NEON	L4 1.6	16-20

OEM 68326414AA, 68326969AA
 *Parque Vehicular: 181,334



8623-KIT





7506024159791

COMPLEMENTO PARA SOPORTE DE MOTOR TRASERO

MARCA	MODELO		
CHEVROLET	AVEO	L4 1.5	18-22

OEM 24106263

*Parque Vehicular: 685,912

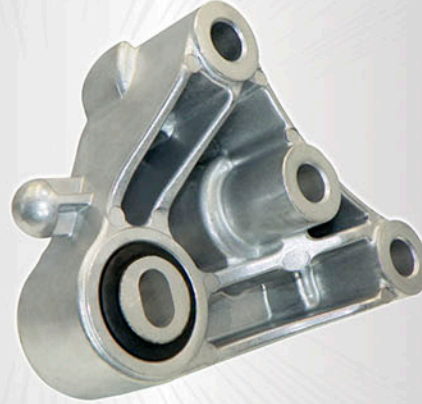

8629



7506024159807

BASE PARA AMORTIGUADOR TRASERA IZQUIERDA

MARCA	MODELO		
NISSAN	X-TRAIL	L4 2.5	02-07

OEM 55265-8H500

*Parque Vehicular: 262,961



8630-KIT



7506024159838

SOPORTE PARA MOTOR FRONTAL

MARCA	MODELO		
LEXUS	CT200H	L4 1.8	11-17
TOYOTA	PRIUS	L4 1.8	10-17

OEM 12361-37090, 12361-37150

*Parque Vehicular: 28,262



8633





7506024159845

**COMPLEMENTO PARA SOPORTE
 DE MOTOR TRASERO**

MARCA	MODELO		
PEUGEOT	PARTNER	L4 1.6	00-09

OEM 1806 H1

*Parque Vehicular: 40,210



8634



7506024159852

**SOPORTE PARA TRANSMISIÓN
 IZQUIERDO Y DERECHO**

MARCA	MODELO		
ISUZU	ELF 200	L4 2.9	09-16
ISUZU	ELF 300	L4 2.9	09-16

OEM 8941119030

*Parque Vehicular: 14,894



8635



7506024159869

**SOPORTE PARA MOTOR
 IZQUIERDO Y DERECHO**

MARCA	MODELO		
TOYOTA	LAND CRUISER	L4 2.4	1987
TOYOTA	LAND CRUISER	L6 4.0	88-90
TOYOTA	LAND CRUISER	L6 4.2	81-87

OEM 12361-60022

*Parque Vehicular: 1,017

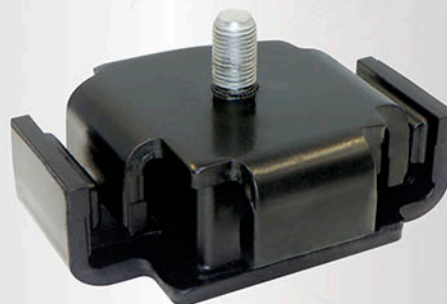

8636





7506024159883

**BASE PARA AMORTIGUADOR
FRONTAL IZQUIERDA Y DERECHA**

MARCA	MODELO		
HYUNDAI	IONIQ	HYBRIDO	17-21
HYUNDAI	ELANTRA	L4 1.4	17-20
KIA	FORTE	L4 2.0	19-20
KIA	NIRO	L4 1.6	19-20
KIA	SOUL	L4 2.0	20-21

OEM 54610-F2000, 54610-F3000, 54612-C1000

*Parque Vehicular: 137,920



8638-KIT



7506024161435

SOPORTE PARA MOTOR IZQUIERDO

MARCA	MODELO		
BMW	320i	L4 2.0	13-14
BMW	320i XDRIVE	L4 2.0	13-14
BMW	328d	L4 2.0 D	14-18
BMW	328d XDRIVE	L4 2.0 D	14-18
BMW	328i	L4 2.0	12-14
BMW	328i XDRIVE	L4 2.0	13-16
BMW	428i XDRIVE	L4 2.0	14-16
BMW	428i XDRIVE GRAN COUPE	L4 2.0	15-16
BMW	430i	L4 2.0	17-20
BMW	430i XDRIVE	L4 2.0	15-20
BMW	430i XDRIVE GRAN COUPE	L4 2.0	17-20
BMW	X3	L6 3.0	11-18
BMW	X4	L6 3.0	15-18



OEM 22-11-6-785-711

22-11-6-787-657

*Parque Vehicular: 40,229

8715-H



8641



7506024159913

BASE PARA AMORTIGUADOR TRASERA IZQUIERDA Y DERECHA

MARCA	MODELO		
AUDI	A4	L4 2.0	09-16
AUDI	A4 QUATTRO	L4 2.0	09-16
AUDI	A4 QUATTRO	V6 3.2	09-09
AUDI	A5	L4 2.0	10-14
AUDI	A5 QUATTRO	L4 2.0	10-17
AUDI	A5 QUATTRO	V6 3.2	08-10
AUDI	ALLROAD	L4 2.0	13-16
AUDI	Q5	L4 2.0	11-17
AUDI	Q5	V6 3.0	13-17
AUDI	Q5	V6 3.2	09-12
AUDI	RS5	V8 4.2	13-15
AUDI	S4	V6 3.0	10-16
AUDI	S5	V6 3.0	10-17
AUDI	S5	V8 4.2	08-12
AUDI	SQ5	V6 3.0	14-17
PORSCHE	MACAN	L4 2.0	17-20
PORSCHE	MACAN	V6 3.0	17-20
PORSCHE	MACAN	V6 3.6	15-18
SEAT	EXEO	L4 2.0	2011



OEM 8K0-513-353-E

*Parque Vehicular: 57,222

64867



7506024159029

JUEGO DE GOMAS PARA BARRA ESTABILIZADORA TRASERA

Ø: 15mm

MARCA	MODELO		
VOLKSWAGEN	BEETLE	L4 1.8	14-17
VOLKSWAGEN	BEETLE	L4 2.0	12-19
VOLKSWAGEN	BEETLE	L5 2.5	12-14
VOLKSWAGEN	JEETA	L4 1.8	14-18
VOLKSWAGEN	JEETA	L4 1.9	05-06
VOLKSWAGEN	JEETA	L4 2.0	06-18
VOLKSWAGEN	JEETA	L5 2.5	05-14



OEM 1K0 511 327 BA, 1K0-511-327-BA

*Parque Vehicular: 145,2727

64868



7506024159036

BUJE PARA EJE TRASERO

MARCA	MODELO		
PEUGEOT	307	L4 2.0	04-10

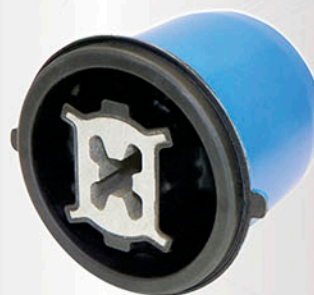

OEM 5131 G4, 5131.G4

*Parque Vehicular: 20,603

64875



7506024159920

BUJE PARA HORQUILLA CHICO

MARCA	MODELO		
CHEVROLET	SPARK	L4 1.4	16-20

OEM 95949751, 95952783
*Parque Vehicular: 309,292



64879



7506024161381

BUJE PARA SUB. CHASIS TRASERO IZQUIERDO Y DERECHO

MARCA	MODELO		
NISSAN	X-TRAIL	L4 2.5	02-07

OEM 55400-8H300
*Parque Vehicular: 262,961



DAI-K-6337



7506024161237

JUEGO DE GOMAS PARA BARRA CAJA DE DIRECCIÓN HIDRÁULICA

MARCA	MODELO		
CHEVROLET	BERETTA	L4 2.0	87-96
CHEVROLET	CAVALIER	L4 1.2	82-94
CHEVROLET	Z-24	L4 2.5	82-94
OLDSMOBILE	CALAIS	L4 2.5	87-88
OLDSMOBILE	CUTLASS	L4 2.5	86-94

OEM 26047683, 26000626
*Parque Vehicular: 290,938

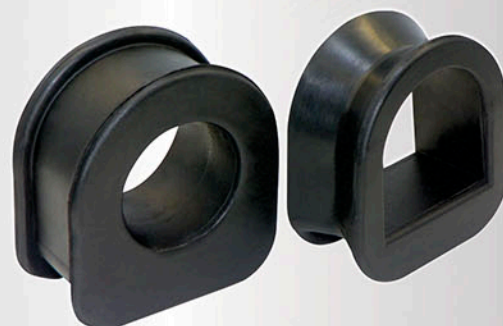

DAI-EV-119



7506024161312

BUJE PARA VARILLA DE DIRECCIÓN

MARCA	MODELO		
BUICK	SKYLARK	L4 2.5	86-98
BUICK	SKYHAWK	L4 2.5	82-89
BUICK	SOMERSET	L4 2.5	85-87
CHEVROLET	BERETA	N/D	87-96
CHEVROLET	CAVALIER	L4 2.2	82-94
CHEVROLET	CORSICA	L4 2.0	87-96
CHEVROLET	Z-24	N/D	82-94
OLDSMOBILE	ACHIEVA	L4 2.3	92-98
OLDSMOBILE	CALAIS	L4 2.3	85-91
OLDSMOBILE	FIRENZA	N/D	85-91
PONTIAC	GRAND AM	L4 2.3	85-98
PONTIAC	LEMANS	N/D	88-93
PONTIAC	SUNBIRD	L4 2.0	82-94

OEM 7834678

*Parque Vehicular: 110,2919





7506024161251

GOMA PARA BARRA CAJA DE DIRECCIÓN HIDRÁULICA

MARCA	MODELO		
CHRYSLER	DAYTONA	L4 2.2	84-88
CHRYSLER	LEBARON K	L4 2.2	82-88
CHRYSLER	NEW YORKER	L4 2.0	82-88
CHRYSLER	TOWN & COUNTRY	V6 3.0	84-90
CHRYSLER	VOYAGER	L4 2.2	84-90
DODGE	CARAVAN	L4 2.2	84-90
DODGE	CHARGER	V6 3.7	83-87
DODGE	CORONET	N/D	83-87
DODGE	DART K	L4 2.2	82-98
DODGE	GRAND CARAVAN	L4 2.2	84-95
DODGE	MAGNUM K	L4 2.2	82-88
DODGE	OMNI ROYAL	L4 2.0	78-90
DODGE	MINIVAN	N/D	84-88
PLYMOUTH	CARAVELLE	L4 2.0	85-88
PLYMOUTH	VOLARE K	L4 2.2	82-88

OEM 3643471

*Parque Vehicular: 670,5293



DAI-K-7110





7506024161244

GOMA PARA BARRA CAJA DE DIRECCIÓN HIDRÁULICA

MARCA	MODELO		
CHRYSLER	ACCALAIM	N/D	89-95
CHRYSLER	DAYTONA	L4 2.2	84-88
CHRYSLER	EUROPA	N/D	82-88
CHRYSLER	GRAND VOYAGER	L4 2.5	84-95
CHRYSLER	LEBARON K	L4 2.0	82-95
CHRYSLER	NEON	L4 2.0	95-99
CHRYSLER	NEW YORKER	L4 2.2	82-95
CHRYSLER	PHANTOM	L4 2.2	89-95
CHRYSLER	SHADOW	L4 2.2	89-95
CHRYSLER	SPIRIT	L4 2.5	89-95
CHRYSLER	TOWN & COUNTRY	V6 3.0	84-95
CHRYSLER	VOYAGER	L4 2.5	84-95
DODGE	ARIES	L4 2.2	81-88
DODGE	CARAVAN	L4 2.2	84-95
DODGE	CHARGER	V8 5.2	83-87
DODGE	CORONET	N/D	83-87
DODGE	DART K	L4 2.2	82-88
DODGE	GRAND CARAVAN	L4 2.2	84-95
DODGE	MAGNUM K	L4 2.2	82-88
DODGE	OMNI ROYAL	L4 2.2	78-90
DODGE	MINIVAN	N/D	84-88
PLYMOUTH	CARAVELLE	L4 2.2	85-88
PLYMOUTH	SUNDANCE	V6 3.0	89-95
PLYMOUTH	VOLARE K	L4 2.2	82-88

DAI-K-7113



OEM 3643471

*Parque Vehicular: 110,2919



7506024161428

BUJE PARA HORQUILLA INFERIOR GRANDE

MARCA	MODELO		
DODGE	ATTITUDE	L4 1.4	12-14
HYUNDAI	ACCENT	L4 1.6	11-17
HYUNDAI	ELANTRA	L4 1.8	11-16
HYUNDAI	VELOSTER	L4 1.6	12-17
KIA	FORTE	L4 2.0	14-21
MITSUBISHI	MIRAGE	L3 1.2	17-20

OEM 54584-3X000

*Parque Vehicular: 486,141



DAI-1406138



7506024161374

BUJE PARA HORQUILLA CHICO

MARCA	MODELO		
DODGE	ATTITUDE	L4 1.4	12-14
HYUNDAI	ACCENT	L4 1.6	11-20
HYUNDAI	ELANTRA	L4 1.8	11-16
HYUNDAI	GRAND I10	L4 1.2	15-22
HYUNDAI	VENUE	L4 1.6	20-22

OEM 54551-1R000

*Parque Vehicular: 486,141



DAI-1406144





7506024150477

JUEGO DE GOMAS PARA BARRA ESTABILIZADORA FRONTAL

MARCA	MODELO		
FORD	EXPEDITION	V8 4.6	97-02
FORD	F-150	V8 4.6	97-07
FORD	F-250	V8 4.6	97-99
FORD	LOBO	V8 4.6	97-03
LINCOLN	NAVIGATOR	V8 5.4	97-02

OEM XL1Z-5484-FA

*Parque Vehicular: 824,139



DAI-1408027



7506024147026

BUJE PARA HORQUILLA INFERIOR CHICO

MARCA	MODELO		
HONDA	CIVIC	L4 1.7	01-05
HONDA	CR-V	L4 2.4	02-06
HONDA	CR-X	L4 1.5	01-05
HONDA	ELEMENT	L4 2.4	03-11

OEM N/D

*Parque Vehicular: 639,526



DAI-1409002





7506024159111

JUEGO DE GOMAS PARA BARRA ESTABILIZADORA

MARCA	MODELO		
RENAULT	DUSTER	L4 2.0	11-21

OEM 82 00 852 550

*Parque Vehicular: 98,472



DAI-1419005



7506024161275

JUEGO DE GOMAS PARA BARRA ESTABILIZADORA FRONTAL

MARCA	MODELO		
SEAT	CORDOBA	L4 1.6	01-02
VOLKSWAGEN	GOLF A3	L4 1.8	92-99
VOLKSWAGEN	JETTA A3	L4 1.8	92-99

OEM 191-411-314

*Parque Vehicular: 172,7288



DAI-1426015



7506024161145

TORNILLO ESTABILIZADOR TRASERO IZQUIERDO Y DERECHO

MARCA	MODELO		
DODGE	JOURNEY	L4 2.4	09-20
DODGE	JOURNEY	V6 3.5	09-20
DODGE	JOURNEY	V6 3.6	09-20

OEM 68052655AA

*Parque Vehicular: 112,238



DAI-2106057





7506024161190

BUJE PARA HORQUILLA INFERIOR GRANDE (BUJE ACERO)

MARCA	MODELO		
AUDI	A1	L4 1.4	11-18
AUDI	A3	L4 1.8	04-12
AUDI	Q3	L4 2.0	13-19
SEAT	ALTEA	L4 2.0	04-15
SEAT	CORDOBA	L4 1.6	01-09
SEAT	IBIZA	L4 1.6	01-08
SEAT	LEON	L4 1.4	06-13
VOLKSWAGEN	BEETLE	L4 1.8	12-19
VOLKSWAGEN	BORA	L4 1.8	06-10
VOLKSWAGEN	CADDY	L4 1.9	10-15
VOLKSWAGEN	CROSSFOX	L4 1.2	07-12
VOLKSWAGEN	EOS	L4 1.6	09-10
VOLKSWAGEN	GLI	L4 2.0	22-23
VOLKSWAGEN	GOLF A4	L4 2.0	06-11
VOLKSWAGEN	GOLF A5	L4 1.8	06-09
VOLKSWAGEN	GOLF A6	L4 1.8	10-12
VOLKSWAGEN	GOLF A7	L4 1.8	13-19
VOLKSWAGEN	JETTA A5	L4 1.4	06-18
VOLKSWAGEN	JETTA A6	L4 1.8	10-18
VOLKSWAGEN	JETTA A8	L4 1.8	19-20
VOLKSWAGEN	LUPO	L4 1.4	05-09
VOLKSWAGEN	PASSAT	L4 1.6	01-08
VOLKSWAGEN	PASSAT CC	L4 1.8	08-15
VOLKSWAGEN	POLO	L4 1.8	03-09
VOLKSWAGEN	R32	L4 1.6	07-09
VOLKSWAGEN	SPORT VAN	L4 1.6	03-07
VOLKSWAGEN	TIGUAN	L4 2.0	09-17
VOLKSWAGEN	TOLEDO	L4 2.0	05-12

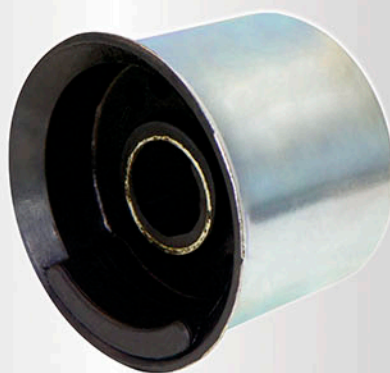

DAI-1426018



OEM 6Q0-407-183-A
*Parque Vehicular: 268,8201



7506024161169

TORNILLO ESTABILIZADOR FRONTAL IZQUIERDO

MARCA	MODELO		
NISSAN	MURANO	V6 3.5	09-14
NISSAN	ROGUE	L4 2.5	08-19
NISSAN	X-TRAIL	L4 2.5	08-22
RENAULT	KOLEOS	L4 2.5	09-23

OEM 54668-1AA0A

*Parque Vehicular: 323,292



DAI-2116033



7506024161176

TORNILLO ESTABILIZADOR FRONTAL DERECHO

MARCA	MODELO		
NISSAN	MURANO	V6 3.5	09-14
NISSAN	ROGUE	L4 2.5	08-19
NISSAN	X-TRAIL	L4 2.5	08-22
RENAULT	KOLEOS	L4 2.5	09-23

OEM 54618-1AA0A

*Parque Vehicular: 323,292



DAI-2116034



7506024161188

TORNILLO ESTABILIZADOR TRASERO IZQUIERDO Y DERECHO

MARCA	MODELO		
NISSAN	NP-300	L4 2.5	16-21
NISSAN	FRONTIER	L4 2.5	16-21

OEM N/D

*Parque Vehicular: 622,281



DAI-2116057





7506024161213

BUJE INFERIOR

MARCA	MODELO		
NISSAN	D-21	L4 2.4	86-96
NISSAN	FRONTIER	L4 2.4	98-04
NISSAN	NP-300	V6 3.0	09-15
NISSAN	PATHFINDER	L4 2.4	87-96
NISSAN	PICK UP	L4 2.4	86-11
NISSAN	URVAN	L4 2.4	00-01
NISSAN	X-TERRA	L4 2.4	98-04

OEM 54560-01G00

*Parque Vehicular: 176,9392

DAI-54560-01G00



7506024161268

JUEGO DE GOMAS PARA BARRA ESTABILIZADORA TRASERA

MARCA	MODELO		
NISSAN	TSUBAME	L4 1.6	92-04
NISSAN	TSUBAME	L4 2.0	92-04
NISSAN	TSURU III	L4 1.6	92-17
NISSAN	TSURU III	L4 2.0	92-17

OEM 55149-52Y10

*Parque Vehicular: 169,2366

DAI-55149-52Y10

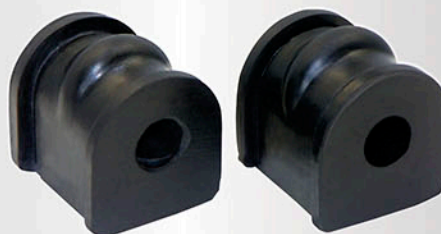

MEDIDAS

2 GOMAS DEL MISMO TAMAÑO

64867

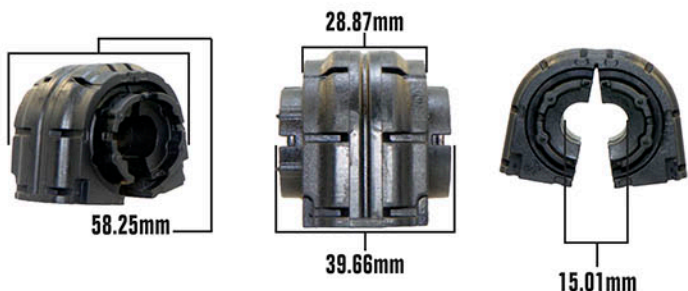

64868

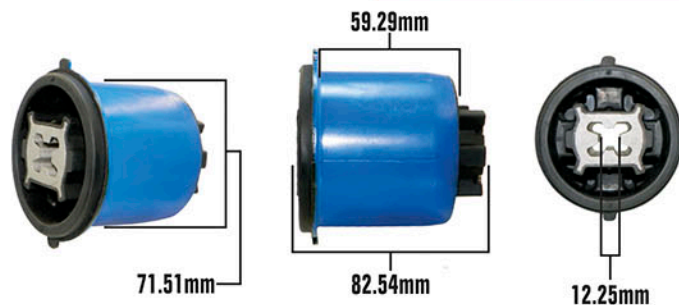

64875

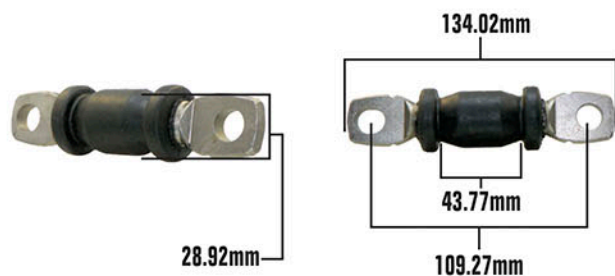

64879

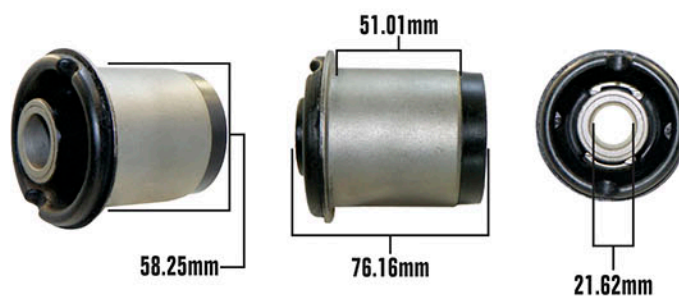

DAI-1406138

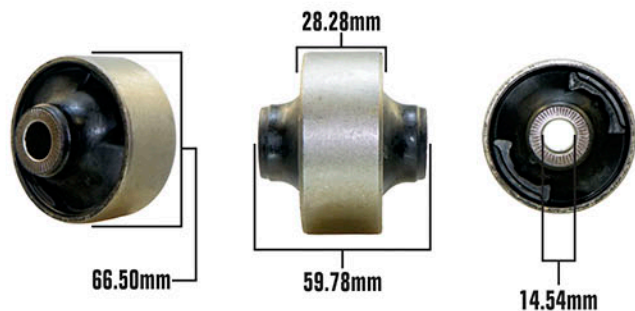

DAI-1406144



MEDIDAS

2 GOMAS DEL MISMO TAMAÑO

DAI-1408027

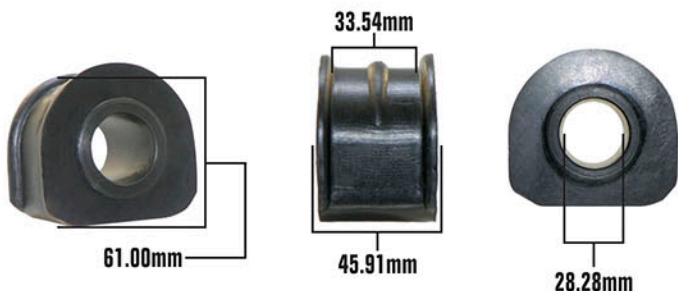

DAI-1409002

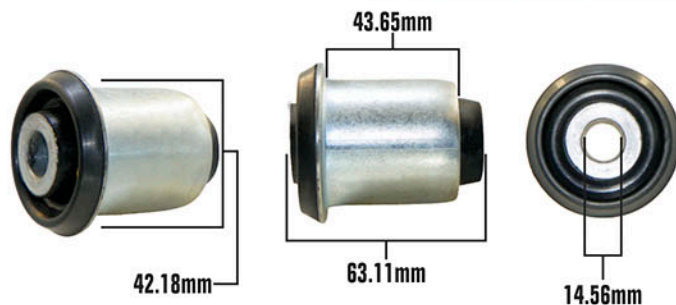

2 GOMAS DEL MISMO TAMAÑO

DAI-1419005

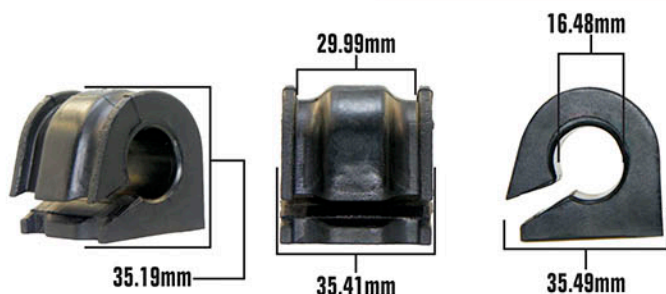

2 GOMAS DEL MISMO TAMAÑO

DAI-1426015

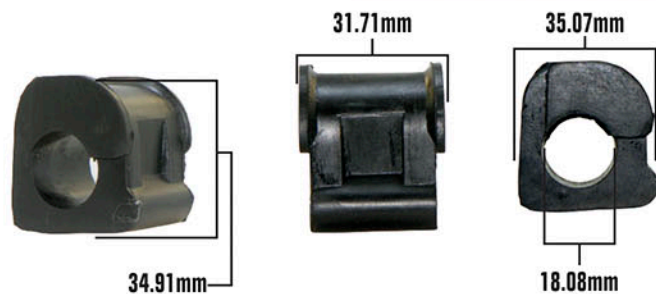

DAI-1426018

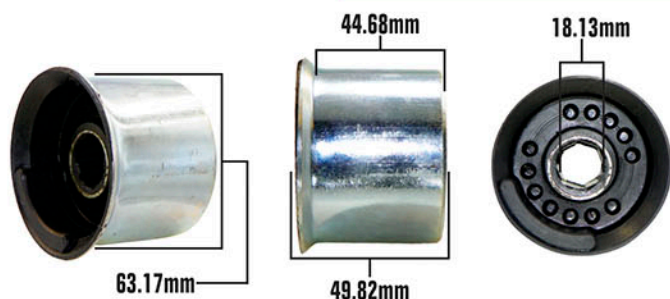

DAI-54560-01 G00

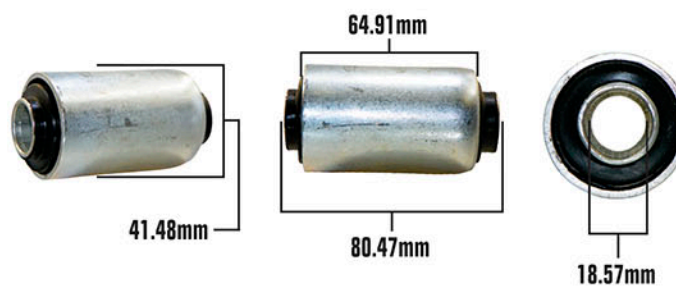

MEDIDAS



En espera de su apoyo para el buen desplazamiento de este producto quedo de ustedes.

Atentamente



Dirección Comercial